

SR.SVD60.85.32

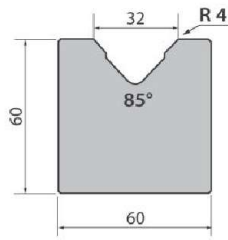

1000 kN/m max.

| | |
|-----------------|---------|
| 835 mm | 21.8 kg |
| 835 mm sections | 21.8 kg |
| 415 mm | 10.6 kg |

SR.SVD60.85.40

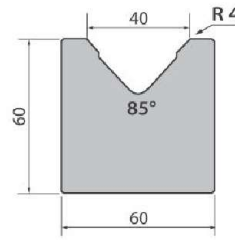

1000 kN/m max.

| | |
|-----------------|---------|
| 835 mm | 19.8 kg |
| 835 mm sections | 19.8 kg |
| 415 mm | 10.4 kg |

SR.SVD60.85.50

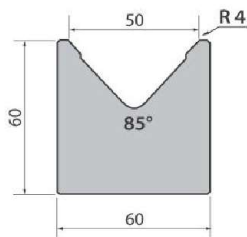

1000 kN/m max.

| | |
|-----------------|---------|
| 835 mm | 19.2 kg |
| 835 mm sections | 19.2 kg |
| 415 mm | 9.6 kg |

SR.SVD75.85.63

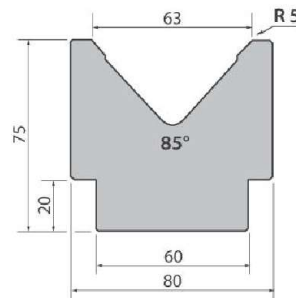

1000 kN/m max.

| | |
|-----------------|---------|
| 835 mm | 29.4 kg |
| 835 mm sections | 29.4 kg |
| 415 mm | 14.6 kg |

SR.SVD80.85.80

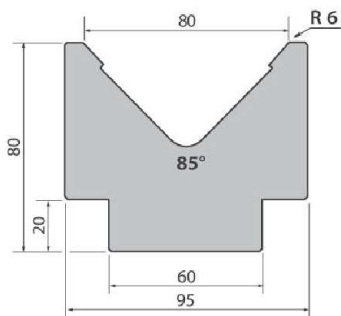

1000 kN/m max.

| | |
|-----------------|---------|
| 835 mm | 33.8 kg |
| 835 mm sections | 33.8 kg |
| 415 mm | 16.7 kg |

SR.SVD95.80.100

1000 kN/m max.

| | |
|-----------------|---------|
| 835 mm | 46,6 kg |
| 835 mm sections | 46,6 kg |
| 415 mm | 23,0 kg |

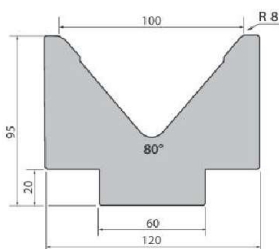

SR.SVD103.80.125

700 kN/m max.

| | |
|-----------------|---------|
| 835 mm | 62,8 kg |
| 835 mm sections | 62,8 kg |
| 415 mm | 31,2 kg |

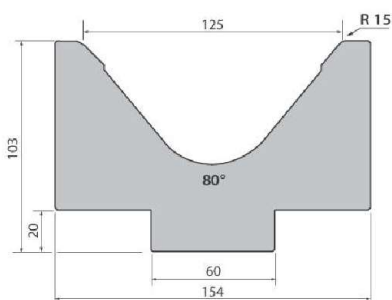

SR.SVD103.80.125S

1000 kN/m max.

| | |
|-----------------|---------|
| 835 mm | 65,0 kg |
| 835 mm sections | 65,0 kg |
| 415 mm | 32,4 kg |

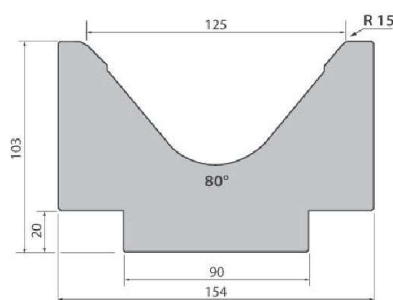

SR.SVD130.80.160

700 kN/m max.

| | |
|-----------------|---------|
| 835 mm | 92,8 kg |
| 835 mm sections | 92,8 kg |
| 415 mm | 46,3 kg |

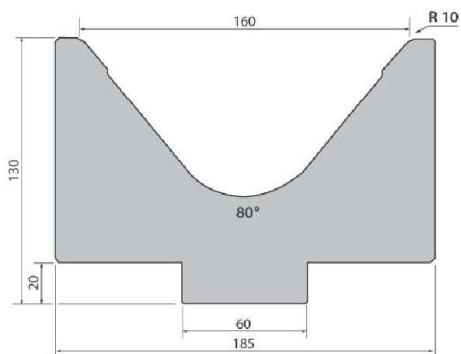

SR.SVD130.80.160

1000 kN/m max.

| | |
|-----------------|---------|
| 835 mm | 92,8 kg |
| 835 mm sections | 92,8 kg |
| 415 mm | 46,3 kg |

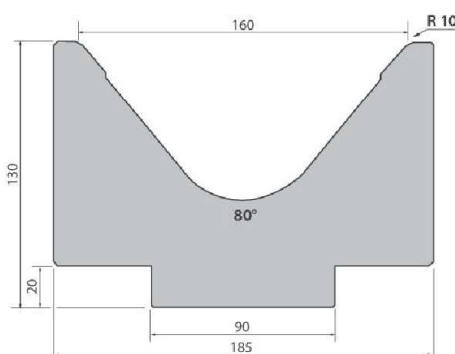

Одноручьевые матрицы 60°

SR.SVD86.60.63

1000 kN/m max.

| | |
|-----------------|---------|
| 835 mm | 34.2 kg |
| 835 mm sections | 34.2 kg |
| 415 mm | 17.0 kg |

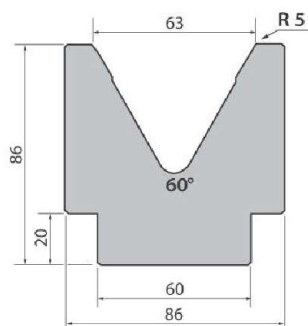

SR.SVD110.60.80

1000 kN/m max.

| | |
|-----------------|---------|
| 835 mm | 54.2 kg |
| 835 mm sections | 54.2 kg |
| 415 mm | 27.0 kg |

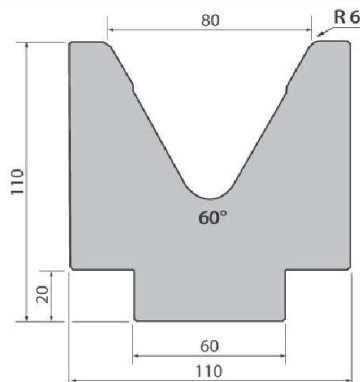

Одноручьевые матрицы 45°

SR.SVD80.45.32

1000 kN/m max.

| | |
|-----------------|---------|
| 835 mm | 27.4 kg |
| 835 mm sections | 27.4 kg |
| 415 mm | 13.8 kg |

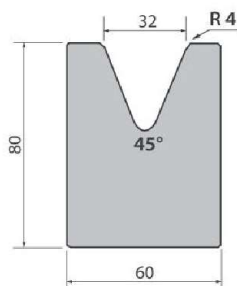

SR.SVD80.45.40

1000 kN/m max.

| | |
|-----------------|---------|
| 835 mm | 31.2 kg |
| 835 mm sections | 31.2 kg |
| 415 mm | 16.6 kg |

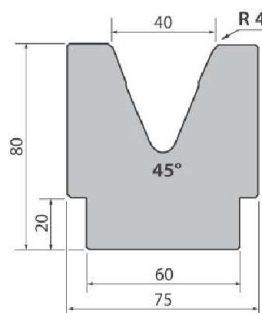

SR.SVD80.45.50

950 kN/m max.

| | |
|-----------------|---------|
| 835 mm | 31.2 kg |
| 835 mm sections | 31.2 kg |
| 415 mm | 15.6 kg |

