

The Power of Quality...

Kalitenin Gücü...



 **Özkayali®**

www.ozkayali.com.tr

01/23 € Fiyat Listesi
12.12.2022 Tarihinden İtibaren Geçerlidir.

Satış Şartlarımız

- 1-) ÖZKAYALI tarafından aksi yazılı olarak kararlaştırılmadıkça, alıcının ürünler için ödeyeceği satın alma bedeli, ÖZKAYALI'nın sevkiyat tarihinde bu ürünler için geçerli olan liste fiyatıdır.
- 2-) Satın alma bedeline alıcının ek olarak ödeyeceği Katma Değer Vergisi dahil değildir.
- 3-) Fiyatlar € döviz cinsinden olup, sipariş tarihinde ödemesi yapılmayan ürünler fatura tarihindeki Merkez bankası € döviz satış kuru üzerinden Tl olarak fatura edilecektir.
- 4-) ÖZKAYALI, önceden haber vermeksizin liste fiyatlarını değiştirme hakkını saklı tutar.
- 5-) Ürünlerin navlun ve sigorta bedeli alıcı'ya aittir.
- 6-) ÖZKAYALI'nın bilgisi haricinde satılan ürün değiştirilemez veya iade edilemez.

HİDROLİK AYNA
GRUBU

Sayfa
04-05



YUMUŞAK ve SERT
AYAKLAR GRUBU

Sayfa
06-09



HASSAS CNC ve
NORMAL DÖNER
PUNTALARI GRUBU

Sayfa
14-18



DEĞİŞİR UÇLU ve
SABİT TIRNAKLI
PUNTALAR GRUBU

Sayfa
19-22



T-SOMUNLAR ve
YUMUŐAK AYAK
TORNALAMA APARATI
GRUBU

Sayfa
10



MENGENE GRUBU
GRUBU

Sayfa
11-13



-REDÜKSİYON KOVANLARI
- MORS KOVANLARI
- MANDREN KONİKLERİ

Sayfa
23-26



 **Özkayali®**

2 Ayaklı Açık Merkez Hidrolik Ayna Standart Model



Sipariş Kodu	Ölçüler	Ağırlık (Kg.)	Fiyat
ÖZ602	6"	10	1.240 €
ÖZ802	8"	26,8	1.591 €
ÖZ102	10"	30	1.823 €
ÖZ122	12"	46	2.894 €

CHS Series

3 Ayaklı Açık Merkez Hidrolik Ayna Standart Model



Sipariş Kodu	Ölçüler	Ağırlık (Kg.)	Fiyat
ÖZ503	5"	8,5	1.120 €
ÖZ603	6"	16	1.244 €
ÖZ803	8"	30	1.474 €
ÖZ103	10"	44	1.901 €
ÖZ123	12"	74	2.705 €
ÖZ153	15"	120	5.091 €

CHS Series

3 Ayaklı Açık Merkez Hidrolik Ayna Sert Ayaklı Model



Sipariş Kodu	Ölçüler	Ağırlık (Kg.)	Fiyat
ÖZ503-3	5"	9,5	1.324 €
ÖZ603-3	6"	18	1.457 €
ÖZ803-3	8"	30	1.720 €
ÖZ103-3	10"	47	2.168 €
ÖZ123-3	12"	78	2.999 €
ÖZ153-3	15"	135	6.058 €

CHS Series

4 Ayaklı Açık Merkez Hidrolik Ayna Standart Model



Sipariş Kodu	Ölçüler	Ağırlık (Kg.)	Fiyat
ÖZ604	6"	16	1.619 €
ÖZ804	8"	28	1.967 €
ÖZ104	10"	44	2.434 €
ÖZ124	12"	76,5	3.297 €
ÖZ154	15"	120	6.770 €

CHS Series

4 Ayaklı Açık Merkez Hidrolik Ayna Sert Ayaklı Model



CHS Series

Sipariş Kodu	Ölçüler	Ağırlık (Kg.)	Fiyat
ÖZ604-4	6"	17,5	1.898 €
ÖZ804-4	8"	32	2.288 €
ÖZ104-4	10"	49	2.784 €
ÖZ124-4	12"	90	3.682 €
ÖZ154-4	15"	140	7.767 €

3 Ayaklı Büyük Açık Merkez Hidrolik Ayna Standart Model



CHB Series

Sipariş Kodu	Ölçüler	Ağırlık (Kg.)	Fiyat
ÖZ6213	6"	12	1.389 €
ÖZ8213	8"	26,5	1.736 €
ÖZ1013	10"	40	2.066 €

3 Ayaklı Büyük Açık Merkez Hidrolik Ayna Sert Ayaklı Model



CHB Series

Sipariş Kodu	Ölçüler	Ağırlık (Kg.)	Fiyat
ÖZ6213-3	6"	14	1.602 €
ÖZ8213-3	8"	28,5	1.982 €
ÖZ1013-3	10"	46,5	2.334 €

Hidrolik Ayna için Pnömatik Silindir



Sipariş Kodu	Çene Stroku	Sıkma Kuvveti kgf/cm ²	Fiyat
PS080	17	1380 kgf/cm ²	636 €
PS010	20	1700 kgf/cm ²	748 €

Hidrolik Ayna için Flanş

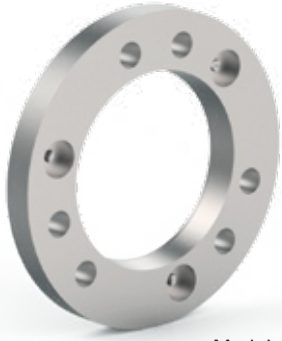

Model 1

Sipariş Kodu	Ayna Çapı	Fiyat
AF5005	5"	104 €
AF6006	6"	116 €
AF8008	8"	124 €
AF1010	10"	134 €
AF1212	12"	143 €
AF1515	15"	149 €

Hidrolik Ayna için Dönüşürme Flanş



Model 2

Sipariş Kodu	Ayna Çevirme Çapı	Flanş No	Fiyat
AF0506	5"-6"	A4	138 €
AF0608	6"-8"	A5	148 €
AF0810	8"-10"	A6	158 €
AF1012	10"-12"	A8	166 €
AF1215	12"-15"	A8	176 €

Standart Yumuşak Ayaklar



Sipariş Kodu	Ayna Çapı	Ağırlık (Kg.)	Fiyat(Set)
YU040	4"	0,5	24 €
YU050	5"	1	25 €
YU060	6"	1,5	25 €
YU080	8"	2,5	28 €
YU0100	10"	3,5	31 €
YU0120	12"	7	40 €
YU01200	12"	6,5	40 €
YU0150	15"	12	62 €
YU02100	21"	18	232 €
YU1518	15"-18"	18	62 €

Standart Yumuşak Ayaklar Sivri Model



Sipariş Kodu	Ayna Çapı	Ağırlık (Kg.)	Fiyat(Set)
YU060S	6"	1,5	25 €
YU080S	8"	2,5	28 €
YU0100S	10"	3,5	31 €

Standart Yumuşak Ayaklar 4 lü Model



Sipariş Kodu	Ayna Çapı	Ağırlık (Kg.)	Fiyat(Set)
YU460	6"	2	33 €
YU480	8"	3,5	38 €
YU104	10"	5	41 €
YU1240	12"	9	54 €
YU0154	15"	16	84 €

Uzun Model Yumuşak Ayaklar



Sipariş Kodu	Ayna Çapı	Ağırlık (Kg.)	Fiyat(Set)
EU060	6"	2	42 €
EU080	8"	3	53 €
EU0100	10"	5	59 €
EU01200	12"	8	68 €
EU0150	15"	14	87 €
EU02100	21"	19,5	246 €

Yüksek Yumuşak Ayaklar Model 01



Sipariş Kodu	Ayna Çapı	Ağırlık (Kg.)	Fiyat(Set)
Y - 060	6"	2,5	37 €
Y - 080	8"	4,5	43 €
Y - 0100	10"	7	53 €
Y - 0120	12"	10	67 €
Y - 01200	12"	10	67 €
Y - 0150	15"	20	137 €

Yüksek Yumuşak Ayaklar Model 02



Sipariş Kodu	Ayna Çapı	Ağırlık (Kg.)	Fiyat(Set)
EY08100	8"	7	98 €
EY08120	8"	8	118 €
EY08130	8"	9	125 €
EY10100	10"	9	109 €
EY10120	10"	11	129 €
EY10130	10"	12	145 €
EY12100	12"	13,5	133 €
EY12120	12"	16	160 €
EY12130	12"	17,5	172 €
EY15130	15"	26	196 €
EY15150	15"	30	225 €

Alüminyum Yumuşak Ayaklar



Sipariş Kodu	Ayna Çapı	Ağırlık (Kg.)	Fiyat(Set)
AL66006	6"	0,7	77 €
AL66008	8"	1	83 €
AL66010	10"	1,5	90 €
AL66012	12"	2	100 €

Kestamit Yumuşak Ayaklar

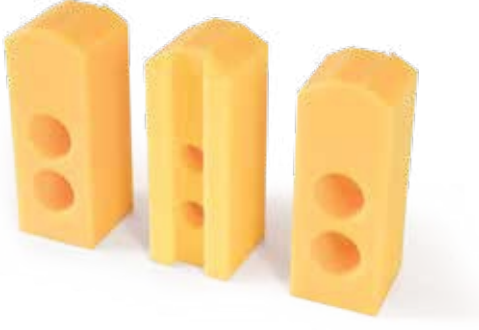

Sipariş Kodu	Ayna Çapı	Ağırlık (Kg.)	Fiyat(Set)
KY 66006	6"	0,3	56 €
KY 66008	8"	0,5	59 €
KY 66010	10"	0,7	66 €
KY 66012	12"	1	74 €

INCH Yumuşak Ayaklar



Sipariş Kodu	Ayna Çapı	Ağırlık (Kg.)	Fiyat(Set)
YA16	6"	1,5	35 €
YA18	8"	2,5	40 €
YA10	10"	4	60 €
YA12	12"	6	80 €

INCH Yumuşak Ayaklar



Sipariş Kodu	Ayna Çapı	Ağırlık (Kg.)	Fiyat(Set)
YR6	6"	2	46 €
YR8	8"	3	51 €
YR10	10"	5	63 €
YR12	12"	6,5	69 €

Daire Yumuşak Ayaklar



Sipariş Kodu	Ayna Çapı	Ağırlık (Kg.)	Fiyat(Set)
DY0660170	6"	9,3	252 €
DY0880210	8"	20	337 €
DY1080250	10"	28	374 €
DY1280300	12"	39	483 €

Sert Ayaklar



Sipariş Kodu	Ayna Çapı	Ağırlık (Kg.)	Fiyat(Set)
S050	5"	0,5	184 €
S060	6"	1	194 €
S080	8"	2	226 €
S0100	10"	3,5	248 €
S0120	12"	10	274 €
S0150	15"	11,5	724 €

Sert Ayaklar 4 lü Model



Sipariş Kodu	Ayna Çapı	Ağırlık (Kg.)	Fiyat(Set)
S064	6"	1,5	259 €
S084	8"	3	302 €
S0104	10"	4,5	331 €
S0124	12"	13,5	366 €
S0154	15"	15,5	966 €

Tırnaklı Sert Ayaklar



Sipariş Kodu	Ayna Çapı	Ağırlık (Kg.)	Fiyat(Set)
ST080110	6"	1	178 €
ST110135	8"	2	193 €
ST155190	10"	3	213 €
ST135195	12"	4	237 €
ST110140	6"	1	190 €
ST135165	8"	1,5	223 €
ST185220	10"	3	236 €
ST195260	12"	4	258 €

Tırnaklı Sert Ayak Yükseltme Vidaları



Sipariş Kodu	Fiyat	Sipariş Kodu	Fiyat
STD0505	3 €	STD0620	3 €
STD0510	3 €	STD0805	3 €
STD0515	3 €	STD0810	3 €
STD0605	3 €	STD0815	3 €
STD0610	3 €	STD0820	3 €
STD0615	3 €	STD0825	3 €

T-Somunlar



3'lü Set

Sipariş Kodu	Ayna Çapı	Ağırlık (Kg.)	Fiyat(Set)
AT100	5"	0,1	33 €
AT101	6"	0,2	35 €
AT102	8"	0,3	42 €
AT104	10"	0,3	50 €
AT106	12"	0,7	54 €
AT107	12"	0,6	54 €
AT15	15"	1,8	180 €
AT108	15"	1,8	180 €

T-Somunlar



4'lü Set

Sipariş Kodu	Ölçüler	Ağırlık (Kg.)	Fiyat(Set)
AT114	6"	0,15	50 €
AT115	8"	0,25	55 €
AT116	10"	0,4	66 €
AT117	12"	0,4	77 €
AT118	12"	0,8	77 €
AT119	15"	2,5	277 €
AT154	15"	2,5	277 €

T-Somunlar



6'lı Set

Sipariş Kodu	Ayna Çapı	Ağırlık (Kg.)	Fiyat (Set)
AT610	6"	0,2	53 €
AT810	8"	0,2	66 €
AT110	10"	0,3	79 €
AT120	12"	0,6	86 €
AT122	12"	1,8	86 €
AT123	15"	1,8	158 €
AT210	21"	2	198 €

Yumuşak Ayak Tornalama Aparatı



Sipariş Kodu	Ayna Çapı	Ağırlık (Kg.)	Fiyat
0505	5"	1	141 €
0605	6"	1,5	149 €
0805	8"	2,5	157 €
1005	10"	4	163 €
1205	12"	5	176 €
1505	15"	11	242 €

Çubuk Çekme Aparatı



Sipariş Kodu	Ağırlık (Kg.)	Fiyat
CTC020	1,7	203 €
CTC025	1,7	203 €

5 Eksen Makina Mengenesi



Sipariş Kodu	Çene Genişliği	Sıkma Aralığı		Ağırlık (Kg.)	Fiyat
		Düz Çn.	Ters Çn.		
CNX75100	75	0-100	65-150	6,5	802 €
CNX75150	75	0-150	65-200	9	863 €
CNX75200	75	0-200	65-250	10	924 €
CNX100150	100	0-100	75-150	11	1.095 €
CNX100350	100	0-250	75-300	19,5	1.197 €
CNX125220	125	0-135	95-220	16	1.238 €
CNX125270	125	0-185	95-270	20	1.343 €
CNX125320	125	0-235	95-320	24	1.410 €

5 Eksen Makina Mengenesi Yedek Parçalar

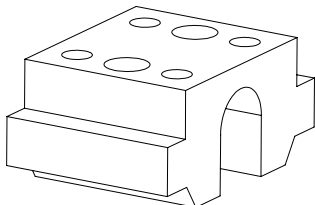
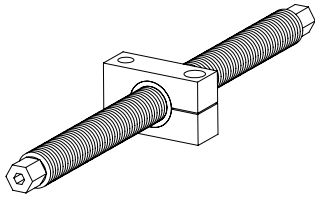
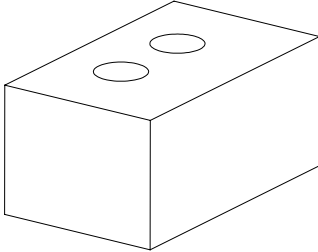
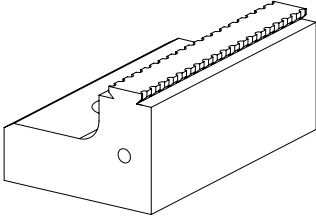

Tırnaklı Sert Çene

Sipariş Kodu	Çene Genişliği	Fiyat(set)
75051	75	390 €
10051	100	446 €
12551	125	504 €

Yumuşak Çene

Sipariş Kodu	Çene Genişliği	Fiyat(set)
75052	75	62 €
10052	100	70 €
12552	125	80 €

Vida ve Blok

Sipariş Kodu	Mengene Kodu	Fiyat(set)
75185	CNX75100	138 €
75235	CNX75150	143 €
75285	CNX75200	147 €
100200	CNX100150	158 €
100350	CNX100350	175 €
125250	CNX125220	155 €
125300	CNX125270	160 €
125350	CNX125320	164 €

Alt Gezer Çene

Sipariş Kodu	Mengene Çene Genişliği	Diş Yönü	Fiyat(adet)
7556R	75	Sağ	133 €
7556L	75	Sol	133 €
10056R	100	Sağ	152 €
10056L	100	Sol	152 €
12556R	125	Sağ	183 €
12556L	125	Sol	183 €

Hassas Tezgaç Mengeleri



Sipariş Kodu	Çene Geniřliđi	Sıkma Kapasitesi	Ađırlık (Kg.)	Fiyat
CTM12513	125	130	20	780 €
CTM15020	150	200	35,5	943 €
CTM15030	150	300	40	1.035 €
CTM17530	175	300	58	1.265 €
CTM20030	200	300	73	1.668 €
CTM20040	200	400	81	1.967 €

Hassas Tezgaç Menge Yedek Parçaları



Hassas Tezgaç Mengenesi Sert Çene TİP 1500

Sipariş Kodu	Çene Uzunl.	Ađırlık (Kg.)	Fiyat(Set)
CT0126	125	1,5	193 €
CT0151	150	2	200 €
CT0176	175	3	207 €
CT0201	200	3,5	214 €



Hassas Tezgaç Mengenesi Sert Çene TİP 1850

Sipariş Kodu	Çene Uzunl.	Ađırlık (Kg.)	Fiyat(Set)
CT0132	125	1,5	234 €
CT0157	150	2	241 €
CT0182	175	3	249 €
CT0207	200	3,5	258 €



Hassas Tezgaç Mengenesi Sert Çene TİP 1250

Sipariş Kodu	Çene Uzunl.	Ađırlık (Kg.)	Fiyat(Set)
CT0130	125	1,5	248 €
CT0155	150	2	257 €
CT0180	175	3	264 €
CT0205	200	3,5	271 €



Hassas Tezgaç Mengenesi Sert Çene TİP 1750

Sipariş Kodu	Çene Uzunl.	Ađırlık (Kg.)	Fiyat(Set)
CT0131	125	1,5	221 €
CT0156	150	2	225 €
CT0181	175	3	230 €
CT0206	200	3,5	241 €

Çoklu Seri Bağlama Mengene



Sipariş Kodu	Ölçüler	İş Parçası Tutma Ad.	Ağırlık (Kg.)	Fiyat
CSM60300	60-300	2	15	906 €
CSM60450	60-450	3	18	1.359 €
CSM70400	70-400	3	23	1.057 €
CSM70600	70-600	4	28	1.663 €

Çoklu Seri Bağlama Mengene Yedek Parçalar

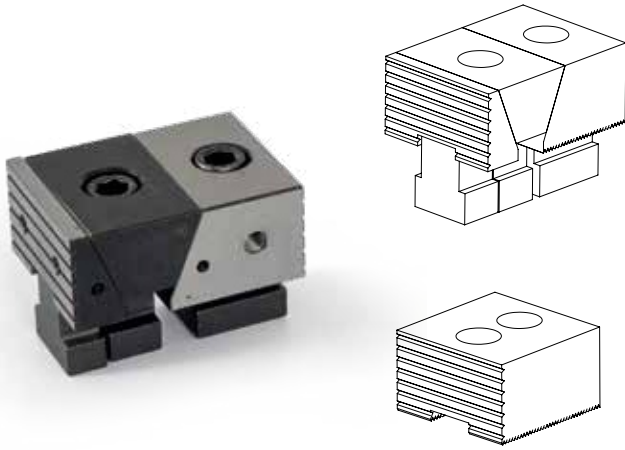

Sipariş Kodu	Çene Uzunluğu	Fiyat(Adet)
CSY600	60	330 €
CSY700	70	374 €

Sipariş Kodu	Çene Uzunluğu	Fiyat(Adet)
CSY610	60	154 €
CSY710	70	176 €

Hassas Hidrolik Makine Mengenesi



Sipariş Kodu	Ağırlık (Kg.)	Fiyat
HM10085	30	1.380 €

Hidro - Pnömatik Makina Mengenesi



Sipariş Kodu	Sıkma Kapasitesi	Ağırlık (Kg.)	Fiyat
HPM135150	0-150	50	2.951 €
HPM170180	0-180	75	3.106 €
HPM200200	0-200	80	3.728 €

Hassas Döner Punta



Model 2005

Sipariş Kodu	MK	Ağırlık (Kg.)	Fiyat
N01	2	1	82 €
N02	3	1,5	103 €
N03	4	2,5	121 €
N04	5	4,5	143 €
N05	6	10	364 €

Hassas CNC Döner Punta



Model 2000

Sipariş Kodu	MK	Ağırlık (Kg.)	Fiyat
C30	3	1,5	130 €
C40	4	2,5	146 €
C50	5	4,5	165 €



Model 2001

Sipariş Kodu	MK	Ağırlık (Kg.)	Fiyat
C60	3	1,5	130 €
C70	4	2,5	146 €
C80	5	4	165 €

Hassas CNC Somunlu Döner Punta



Model 2006

Sipariş Kodu	MK	Ağırlık (Kg.)	Fiyat
CS600	3	2	154 €
CS700	4	3	170 €
CS800	5	5	201 €



Model 2007

Sipariş Kodu	MK	Ağırlık (Kg.)	Fiyat
CS300	3	2	154 €
CS400	4	3	170 €
CS500	5	5	201 €

Hassas Sert Metal Uçlu CNC Döner Punta



Model 2019

Sipariş Kodu	MK	Ağırlık (Kg.)	Fiyat
CE40	4	2,5	265 €
CE50	5	4,5	290 €



Model 207

Sipariş Kodu	MK	Ağırlık (Kg.)	Fiyat(Set)
C104	4	1,5	315 €
C105	5	3,5	358 €



Sipariş Kodu	MK	Fiyat
C1044	4	200 €
C1055	5	226 €



C201

MODEL	Sipariş Kodu	MK	Ağırlık (gr.)	Fiyat(Adet)
C201	C401	4	250	30 €
C202	C402	4	215	30 €
C203	C403	4	200	27 €
C204	C404	4	170	27 €
C205	C405	4	120	27 €
Anahtar	C1030	4	100	30 €



C202



C203



C204



C205

MODEL	Sipariş Kodu	MK	Ağırlık (gr.)	Fiyat(Adet)
C201	C501	5	750	36 €
C202	C502	5	700	35 €
C203	C503	5	560	32 €
C204	C504	5	250	32 €
C205	C505	5	195	32 €
Anahtar	C1040	5	110	36 €



Hassas CNC İnce Çaplı Döner Punta

Model 820



Model 830



Model 840



Sipariş Kodu	MK	Ağırlık (Kg.)	Fiyat
C110	4	1,2	170 €
C140	5	3	199 €

Sipariş Kodu	MK	Ağırlık (Kg.)	Fiyat
C120	4	1,2	170 €
C150	5	3	199 €

Sipariş Kodu	MK	Ağırlık (Kg.)	Fiyat
C130	4	1,2	170 €
C160	5	3	199 €

Şapkalı Boru Döner Puntası



Model 280



Model 270

Sipariş Kodu	MK	Ağırlık (Kg.)	Fiyat (gövde)
C284	4	2,5	180 €
C285	5	4,5	221 €

Sipariş Kodu	MK	ÇAP	UÇ AÇI	Ağırlık (Kg.)	Fiyat
C410	4	60	75°	0,7	48 €
C420	4	100	75°	1,8	81 €
C430	4	150	75°	4	124 €
C440	4	200	75°	7	156 €
C510	5	100	75°	1,5	81 €
C520	5	150	75°	4	124 €
C530	5	200	75°	7	156 €
C540	5	250	75°	11	221 €

Hassas Yüksek Devir CNC Döner Punta

Model S 2002



Model S 2003



Sipariş Kodu	MK	Ağırlık (Kg.)	Fiyat
SC40	4	3,5	243 €
SC50	5	5	255 €

Sipariş Kodu	MK	Ağırlık (Kg.)	Fiyat
SC70	4	3,5	243 €
SC80	5	5	255 €

Ağır Yük Döner Puntası

Model 2004



Sipariş Kodu	MK	Ağırlık (Kg.)	Fiyat
AY040	4	5	140 €
AY050	5	7	329 €
AY060	6	16,5	553 €

Sipariş Kodu	MK	Fiyat
AY080	MT80	Özel
AY0100	MT100	Özel
AY0120	MT120	Özel
AY0140	MT140	Özel

Hassas Döner Boru Puntası



Model 208

Sipariş Kodu	MK	ÇAP	UÇ AÇI	Ağırlık (Kg.)	Fiyat
B70	3	80	60°	2	131 €
B80	4	80	60°	2,5	146 €
B90	3	100	60°	3,5	165 €
B100	4	100	60°	4	174 €
B110	4	120	60°	5	182 €
B120	5	120	60°	6	194 €
B130	4	140	60°	7,5	209 €
B140	5	140	60°	8,5	215 €
B150	5	170	70°	13,5	313 €
B160	5	200	70°	18	409 €
B170	6	200	70°	19,5	443 €
B175	5	255	70°	34	635 €
B180	6	255	70°	35	672 €
B185	5	355	70°	71	Özel
B195	6	355	70°	72	Özel
B200	5	400	45°	90	Özel
B205	6	400	45°	92	Özel

Hassas Somunlu Döner Boru Puntası



Model 209

Sipariş Kodu	MK	ÇAP	UÇ AÇI	Ağırlık (Kg.)	Fiyat
SB0803	3	80	60°	2,5	185 €
SB0804	4	80	60°	2,5	194 €
SB0103	3	100	60°	3,5	217 €
SB0104	4	100	60°	4	229 €
SB1204	4	120	60°	5,5	248 €
SB1205	5	120	60°	6,5	264 €
SB1404	4	140	60°	8	283 €
SB1405	5	140	60°	8	288 €
SB1705	5	170	70°	14	365 €
SB2005	5	200	70°	18,5	463 €

Hassas Normal Sabit Punta

Model 100



Model 200



Sipariş Kodu	MK	Ağırlık (Kg.)	Fiyat
SP100	2	0,3	32 €
SP110	3	0,5	32 €
SP120	4	1	41 €
SP130	5	2	45 €
SP138	6	5,5	123 €

Sipariş Kodu	MK	Ağırlık (Kg.)	Fiyat
ES200	2	0,3	68 €
ES210	3	0,5	75 €
ES220	4	1	95 €
ES230	5	2	112 €

Sert Metal Uçlu Sabit Punta

Model 110



Model 210



Sipariş Kodu	MK	Ağırlık (Kg.)	Fiyat
SPD100	2	0,2	48 €
SPD110	3	0,4	54 €
SPD120	4	0,8	60 €

Sipariş Kodu	MK	Ağırlık (Kg.)	Fiyat
ESD100	2	0,2	164 €
ESD110	3	0,4	185 €
ESD120	4	0,8	203 €

Hassas Somunlu Sabit Punta

Model 2013



Model 2014



Model 2015



Sipariş Kodu	MK	Ağırlık (Kg.)	Fiyat
SP136	3	0,5	70 €
SP137	4	1,5	72 €
SP150	5	3	131 €
SP165	6	4,5	143 €

Sipariş Kodu	MK	Ağırlık (Kg.)	Fiyat
SP140	3	0,5	70 €
SP141	4	1,5	72 €
SP155	5	3	131 €

Sipariş Kodu	MK	Ağırlık (Kg.)	Fiyat
SP144	3	0,5	70 €
SP145	4	1,5	72 €
SP160	5	3	131 €

Hassas Silindir Şaftlı Set Tırnaklı Punta



Model 260

Sipariş Kodu	Şaft Çap	İş Bağ.Çap	Ağırlık (Kg.)	Fiyat(Set)
T400925	40	9-16/16-25	2,5	268 €
T402662	40	26-50/33-62	3	272 €

SET TIRNAKLI PUNTA YEDEK TIRNAK



Sipariş Kodu	Fiyat
T00916	44 €
T01625	44 €
T02650	44 €
T03362	44 €

MODEL T0816

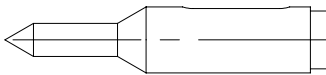

MODEL T0416

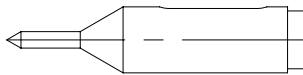

MODEL T0016



MODEL T0721

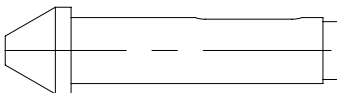

SET TIRNAKLI PUNTA MERKEZ UÇ

Sipariş Kodu	Fiyat
T0016	37 €
T0721	38 €
T0816	33 €
T0416	33 €

Hassas Mors Konik Set Tırnaklı Punta



Model 265

Sipariş Kodu	MK	İş Bađ.Çap	Ağırlık (Kg.)	Fiyat(Set)
T09254	4	9-16/16-25	2	272 €
T09255	5	9-16/16-25	3	276 €
T26624	4	26-50/33-62	2,5	272 €
T26625	5	26-50/33-62	3,5	276 €

SET TIRNAKLI PUNTA
YEDEK TIRNAK

Sipariş Kodu	Fiyat
T00916	44 €
T01625	44 €
T02650	44 €
T03362	44 €

MODEL T0816

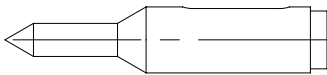

MODEL T0416

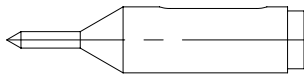

MODEL T0016

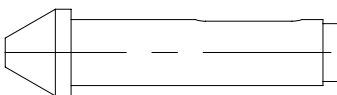

MODEL T0721

SET TIRNAKLI PUNTA
MERKEZ UÇ

Sipariş Kodu	Fiyat
T0016	37 €
T0721	38 €
T0816	33 €
T0416	33 €

Hassas Mekanik Kilitli Tırnaklı Punta



Model 225

Sipariş Kodu	MK	İş Bağlama Çapı	Ağırlık (Kg.)	Fiyat
T180	4	19-35	1,2	202 €
T200	4	26-50	2	208 €
T210	5	26-50	2,5	223 €
T220	4	33-80	2	223 €
T230	5	33-80	3	227 €
T240	5	70-140	11,5	635 €



T180-180

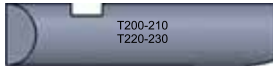

T200-210
T220-230



T240-240

Sipariş Kodu	İçerik	Fiyat
T180-180	3'lü Takım	37 €
T200-210	3'lü Takım	37 €
T220-230	3'lü Takım	40 €
T240-240	6'lı Takım	113 €



T1803

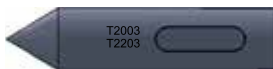

T2003
T2203



T2403

Sipariş Kodu	Fiyat(Adet)
T1803	19 €
T2003	19 €
T2203	19 €
T2403	38 €

Altıköşe Açma Döner Punta

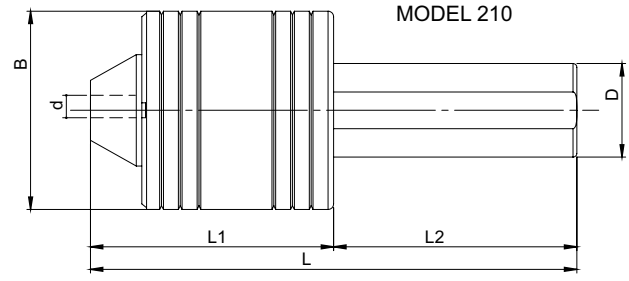

Sipariş Kodu Order Code	Ölçüler / Dimensions						Fiyat
	L	L1	L2	B	D	d	
AD2553	130	54	65	53	25	12	290 €
AD3253	130	54	65	53	32	12	
AD4053	130	54	65	53	40	12	
AD2235	125	48	75	35	20	8	314 €
AD2541	123	47	65	41	25	8	
AD1635	125	48	75	35	16	8	
AD2035	125	48	75	35	20	8	
AD2535	125	48	75	35	25	8	
AD4095	203	103	100	95	40	16	1.203 €

Altıköşe Zimba

Sipariş Kodu Order Code	Ölçüler / Dimensions			Fiyat
	D	A	Fiyat	
AK0802	8	2	42 €	
AK0803	8	3		
AK0804	8	4		
AK0805	8	5		
AK0806	8	6		
AK1203	12	3		50 €
AK1204	12	4		
AK1205	12	5		
AK1206	12	6		
AK1208	12	8		
AK1210	12	10	69 €	
AK1212	12	12		
AK1214	12	14		73 €



Sipariş Kodu Order Code	Ölçüler / Dimensions			Fiyat
	D	A	Fiyat	
AK1614	16	14	95 €	
AK1615	16	15		
AK1616	16	16		
AK1617	16	17	100 €	
AK1618	16	18		
AK1619	16	19		
AK1620	16	20		
AK1621	16	21		
AK1622	16	22	102 €	
AK1623	16	23		
AK1624	16	24		
AK1625	16	25		

CNC Torna Redüksiyon Kovanları



Sipariş Kodu	Dış Çap	İç Çap	Ağırlık (Kg.)	Fiyat
*CK2008	20	8	0,1	18 €
*CK2010	25	10	0,1	18 €

Sipariş Kodu	Dış Çap	İç Çap	Ağırlık (Kg.)	Fiyat
CK2012	20	12	0,1	18 €
CK2016	25	16	0,1	18 €

Sipariş Kodu	Dış Çap	İç Çap	Ağırlık (Kg.)	Fiyat
*CK2508	25	8	0,3	20 €
*CK2510	25	10	0,2	20 €
CK2512	25	12	0,2	20 €

Sipariş Kodu	Dış Çap	İç Çap	Ağırlık (Kg.)	Fiyat
CK2516	25	16	0,2	20 €
CK2520	25	20	0,1	20 €

CNC Torna Redüksiyon Kovanları



Sipariş Kodu	Dış Çap	İç Çap	Ağırlık (Kg.)	Fiyat
*CK3208	32	8	0,5	22 €
*CK3210	32	10	0,5	22 €
*CK3212	32	12	0,5	22 €
*CK3216	32	16	0,4	22 €

Sipariş Kodu	Dış Çap	İç Çap	Ağırlık (Kg.)	Fiyat
CK3220	32	20	0,4	22 €
CK3225	32	25	0,3	22 €

Sipariş Kodu	Dış Çap	İç Çap	Ağırlık (Kg.)	Fiyat
*CK4008	40	8	1	23 €
*CK4010	40	10	1	23 €
*CK4012	40	12	0,8	23 €
*CK4016	40	16	0,8	23 €
*CK4020	40	20	0,7	23 €
CK4025	40	25	0,6	23 €

Sipariş Kodu	Dış Çap	İç Çap	Ağırlık (Kg.)	Fiyat
CK4032	40	32	0,4	23 €

*İşareti bulunan ürünler soğutma su kanalıdır.

CNC Torna Redüksiyon Kovanları



Sipariş Kodu	Dış Çap	İç Çap	Ağırlık (Kg.)	Fiyat
*CK5008	50	8	1.5	31 €
*CK5010	50	10	1.5	31 €
*CK5012	50	12	1.5	31 €
*CK5016	50	16	1.3	31 €
*CK5020	50	20	1.2	31 €
CK5025	50	25	1.0	31 €
CK5032	50	32	0,9	31 €

Sipariş Kodu	Dış Çap	İç Çap	Ağırlık (Kg.)	Fiyat
CK5040	50	40	0,6	31 €

Sipariş Kodu	Dış Çap	İç Çap	Ağırlık (Kg.)	Fiyat
*CK6012	60	12	2.5	51 €
*CK6016	60	16	2.5	51 €
*CK6020	60	20	2.4	51 €
*CK6025	60	25	2.3	51 €
*CK6032	60	32	2	51 €
CK6040	60	40	1.7	51 €

Sipariş Kodu	Dış Çap	İç Çap	Ağırlık (Kg.)	Fiyat
CK6050	60	50	1	51 €

*İşareti bulunan ürünler soğutma su kanallıdır.

CNC Torna Uzatma Redüksiyon Kovanları



Sipariş Kodu	Dış Çap	İç Çap	Fiyat
CKU2508	25	8	23 €
CKU2510	25	10	23 €
CKU2512	25	12	23 €
CKU2516	25	16	23 €

Sipariş Kodu	Dış Çap	İç Çap	Fiyat
CKU3208	32	8	27 €
CKU3210	32	10	27 €
CKU3212	32	12	27 €
CKU3216	32	16	27 €
CKU3220	32	20	27 €

Sipariş Kodu	Dış Çap	İç Çap	Fiyat
CKU4010	40	10	28 €
CKU4012	40	12	28 €
CKU4016	40	16	28 €
CKU4020	40	20	28 €
CKU4025	40	25	28 €

Sipariş Kodu	Dış Çap	İç Çap	Fiyat
CKU5016	50	16	37 €
CKU5020	50	20	37 €
CKU5025	50	25	37 €
CKU5032	50	32	37 €

CNC Torna Mors Adaptörü



Sipariş Kodu	Dış Çap	MK	Ağırlık (Kg.)	Fiyat
CM321	32	1	0,5	34 €
CM322	32	2	0,4	34 €
CM323	32	3	0,3	34 €
CM401	40	1	0,8	36 €
CM402	40	2	0,7	36 €
CM403	40	3	0,6	36 €
CM404	40	4	0,7	36 €

CNC Torna Mandren Tutucusu



Sipariş Kodu	Ürün	Ağırlık (Kg.)	Fiyat
CM1625	16x25	0,3	24 €
CM1825	18x25	0,3	24 €
CM1832	18x32	0,5	27 €
CM2232	22x32	0,6	27 €
CM1840	18x40	0,9	29 €
CM2240	22x40	0,9	29 €
CM2440	24x40	0,9	29 €

Hassas Mandren Koniği



Sipariş Kodu	Ürün	Ağırlık (Kg.)	Fiyat
M20	12x2	0,1	18 €
M30	16x2	0,2	18 €
M40	18x2	0,2	18 €
M50	16x3	0,3	19 €
M60	18x3	0,3	19 €
M70	22x3	0,4	19 €
M80	24x3	0,4	19 €
M90	16x4	0,3	20 €
M100	18x4	0,7	20 €
M110	22x4	0,7	20 €
M120	24x4	0,7	20 €
M130	18x5	1,6	29 €
M140	22x5	1,6	29 €
M150	24x5	2	29 €

Hassas Mors Kovanları



Sipariş Kodu	Ürün	Ağırlık (Kg.)	Fiyat
V010	2X1	0,1	24 €
V111	3X1	0,2	26 €
V011	3X2	0,2	26 €
V012	4X2	0,5	27 €
V013	4X3	0,4	27 €
V014	5X3	1,2	37 €
V015	5X4	1	37 €
V016	6X5	3	99 €

Hassas Uzatma Mors Kovanı



Sipariş Kodu	Ürün	Ağırlık (Kg.)	Fiyat
UV04	2X3	0,6	66 €
UV05	3X2	0,5	66 €
UV06	3X3	0,7	66 €
UV07	3X4	1,5	76 €
UV08	4X3	1	76 €
UV09	4X4	1,7	76 €
UV10	4X5	3,3	106 €
UV11	5X4	2,8	106 €
UV12	5X5	4,3	106 €

THE POWER OF
QUALITY
KALİTENİN GÜCÜ

www.ozkayali.com.tr



Büsan Özel Organize San. Çelik Cd. No: 45-47 Karatay / Konya / TURKEY
Tel: +90 332 345 46 14- 15 - Fax: +90 332 345 46 17
www.ozkayali.com.tr - info@ozkayali.com.tr - export@ozkayali.com.tr